

$$\beta = (2\pi/\lambda) \times \text{Modal Index}$$

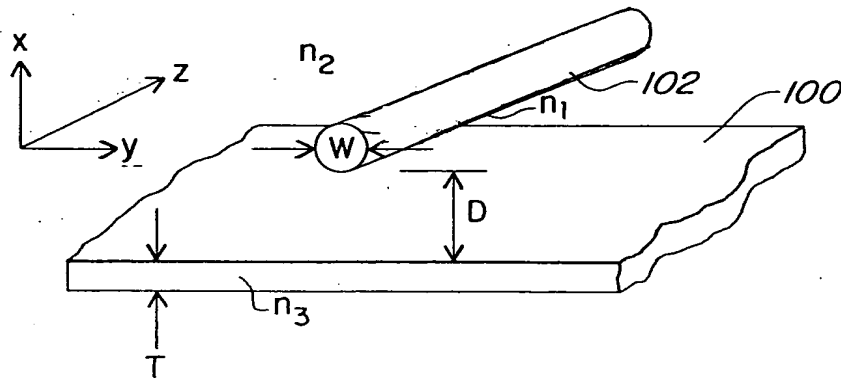

**FIG. 1**

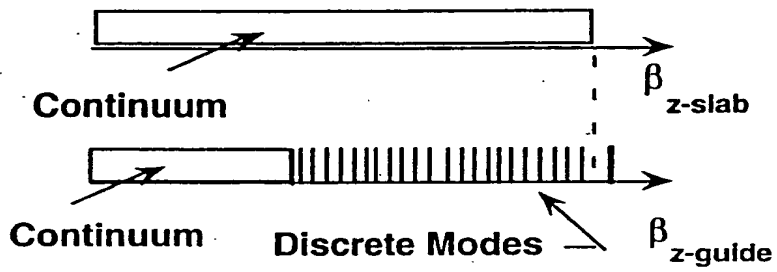
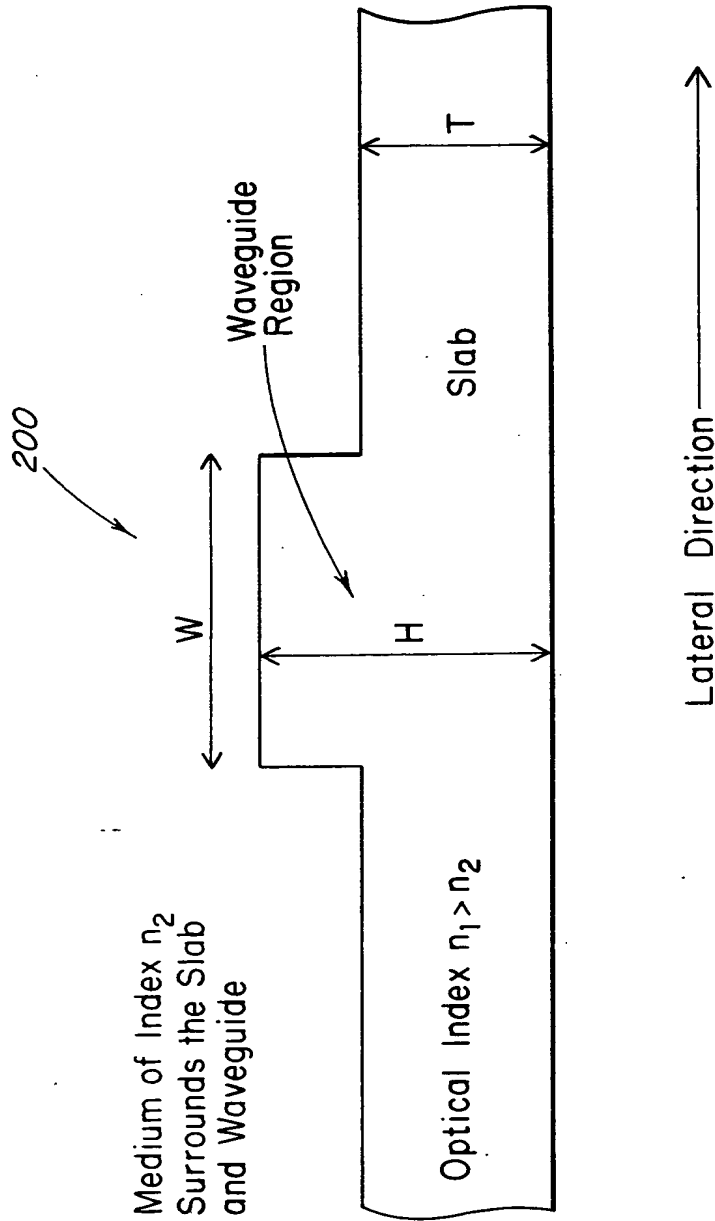

**FIG. 2**

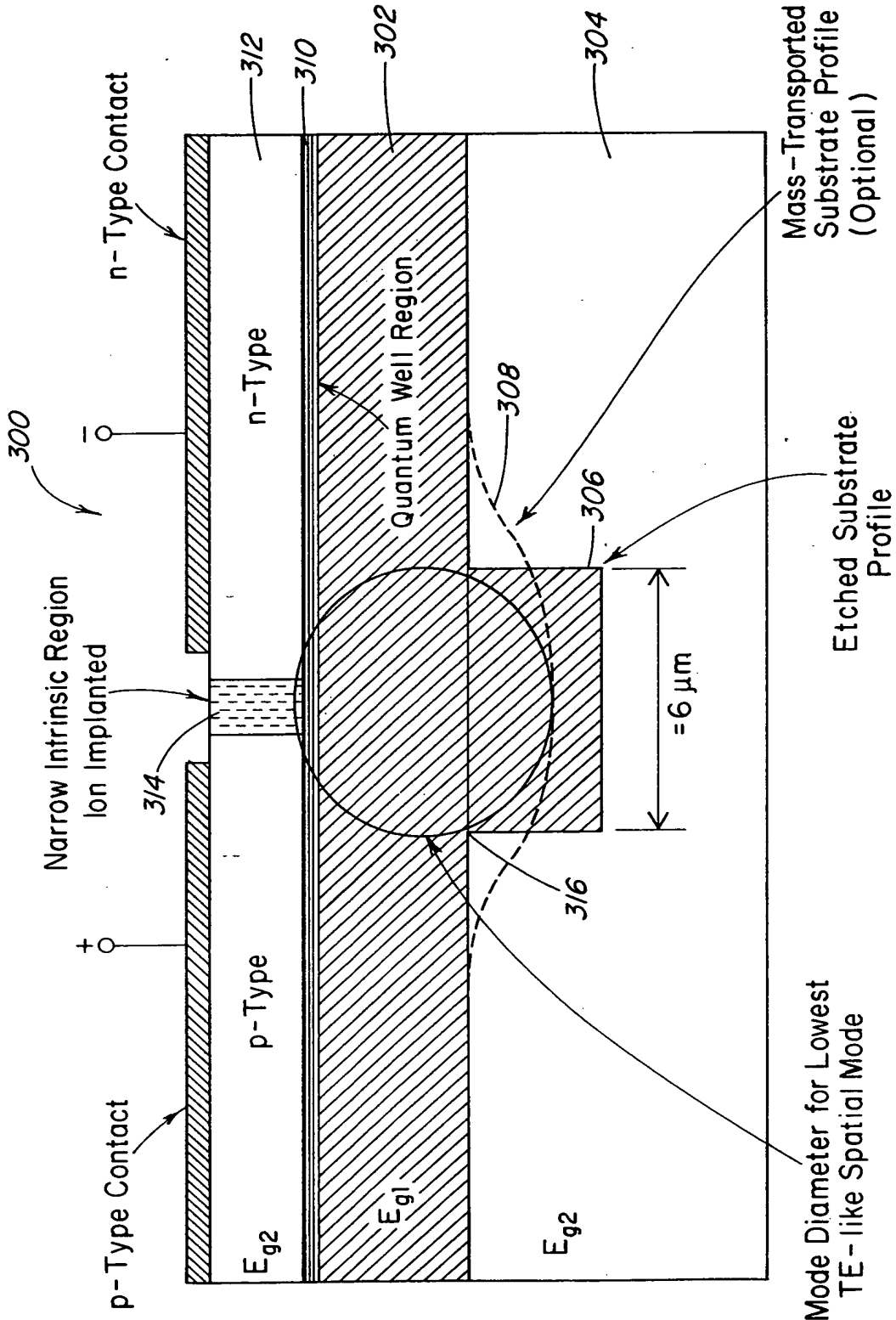

FIG. 3

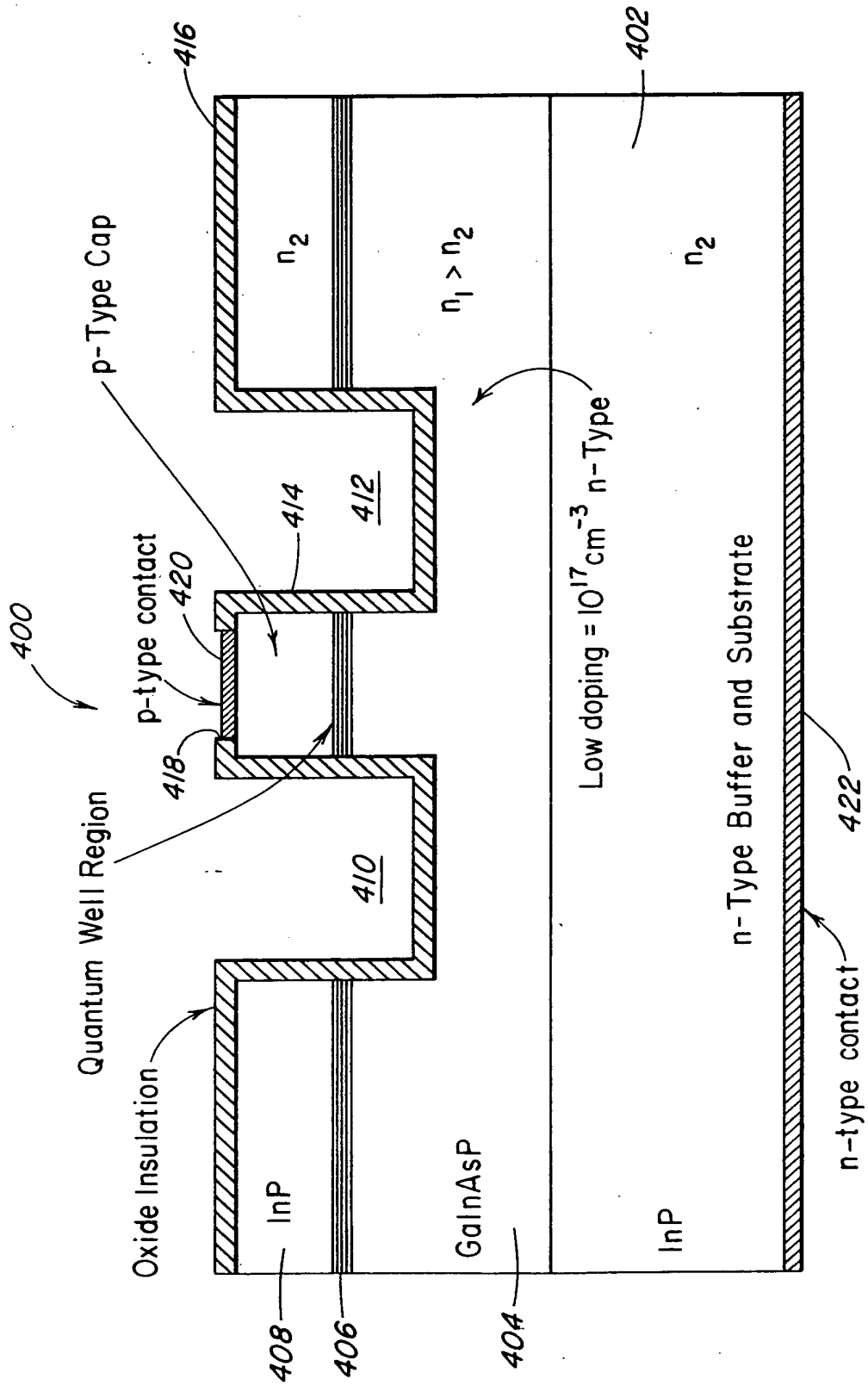
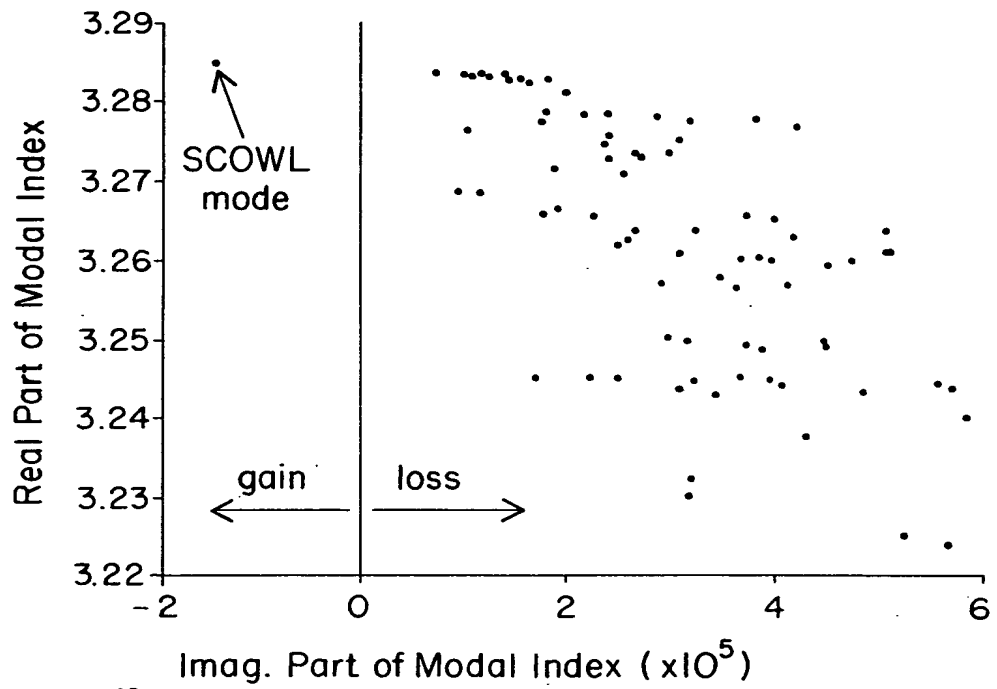
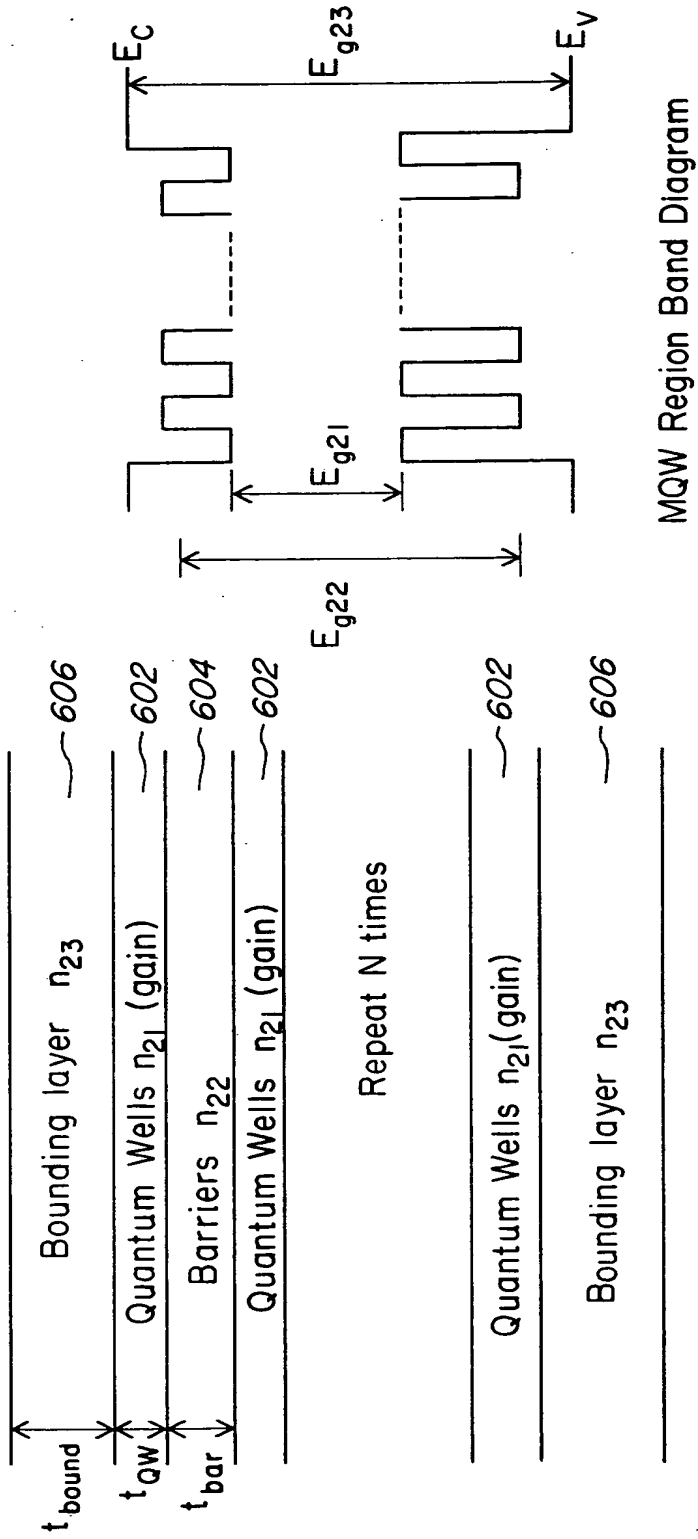

FIG. 4



**FIG. 5**

600 ↗



$$n_{21} > n_{22} \geq n_{23} \geq n_1 > n_2$$

$$E_{g21} < E_{g22} \leq E_{g23} \leq E_{g1}$$

FIG. 6

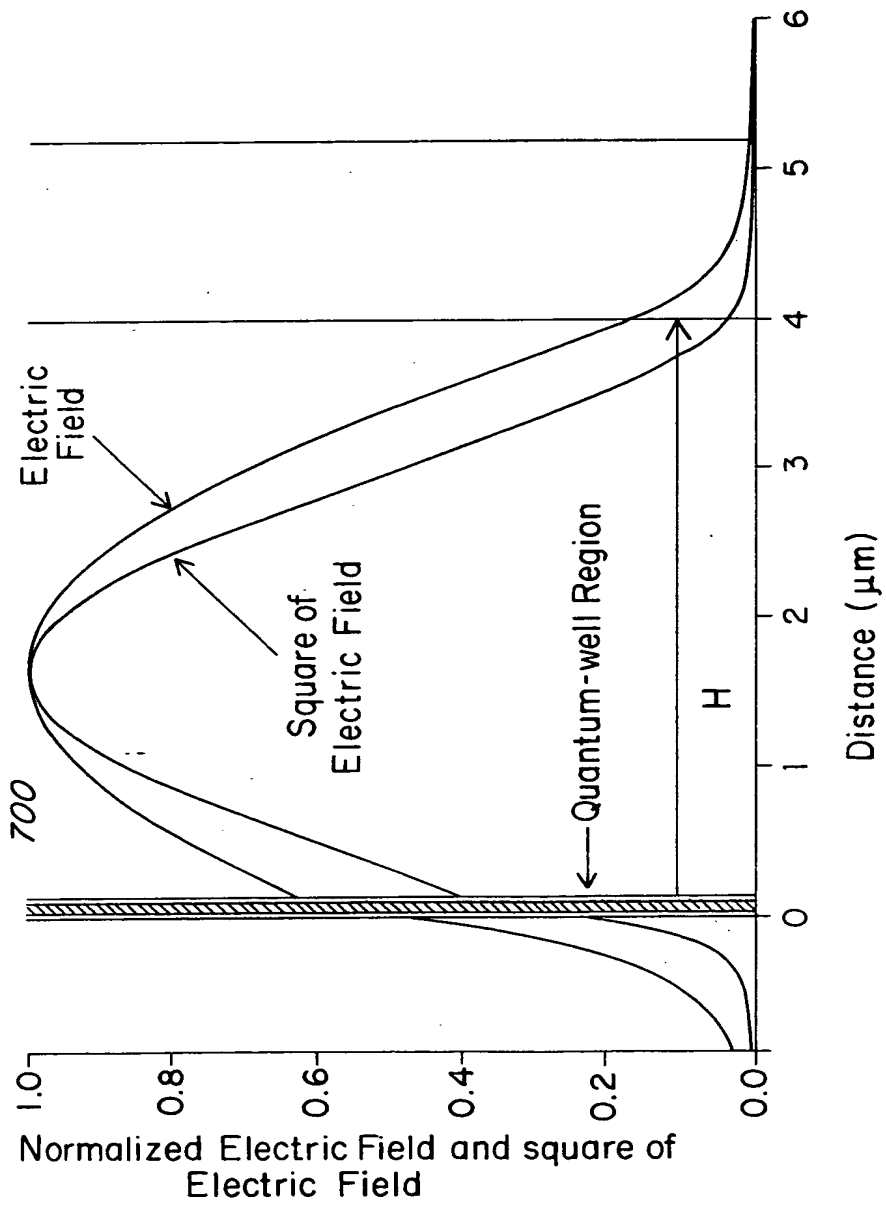

**FIG. 7**

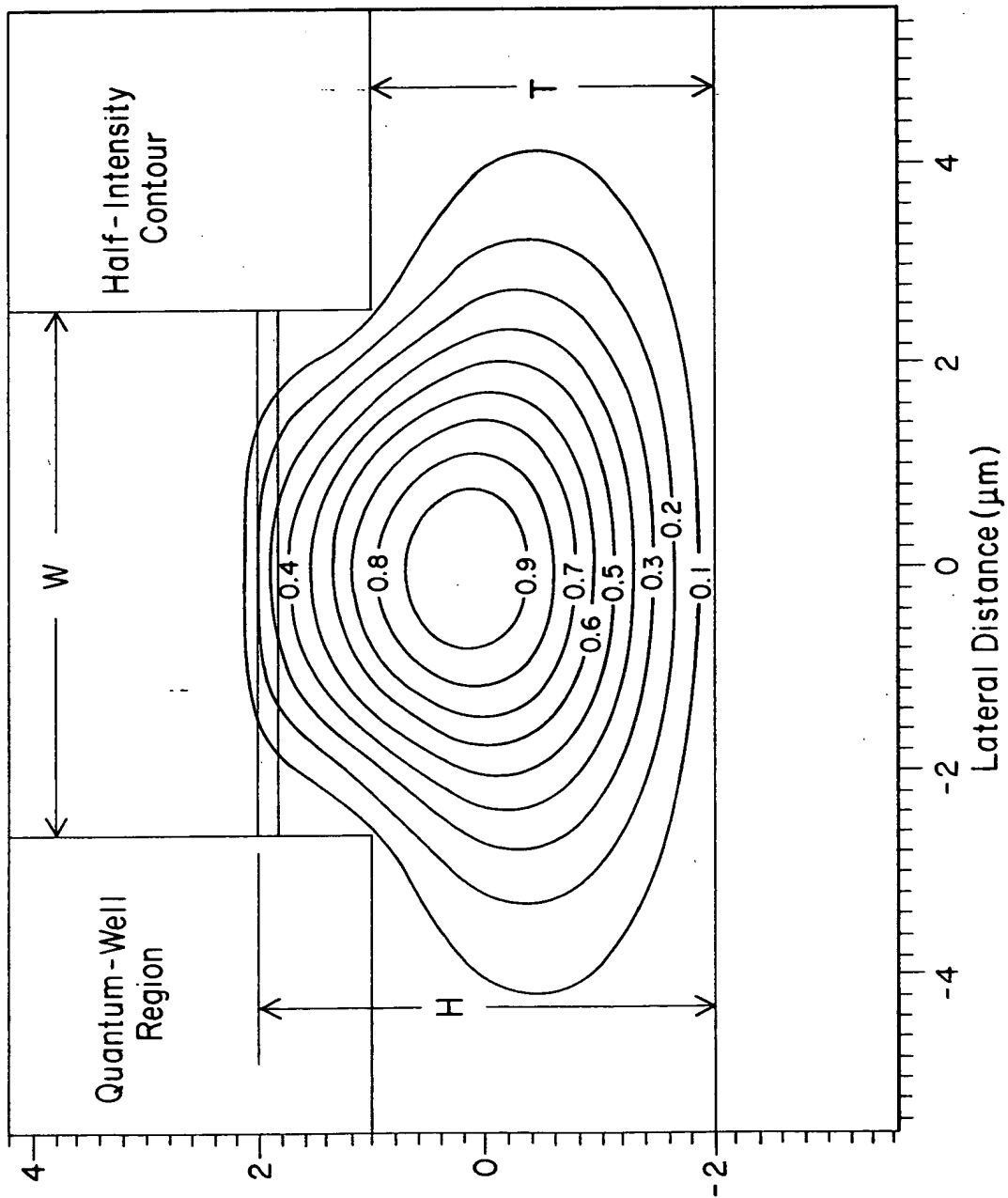

**FIG. 8**



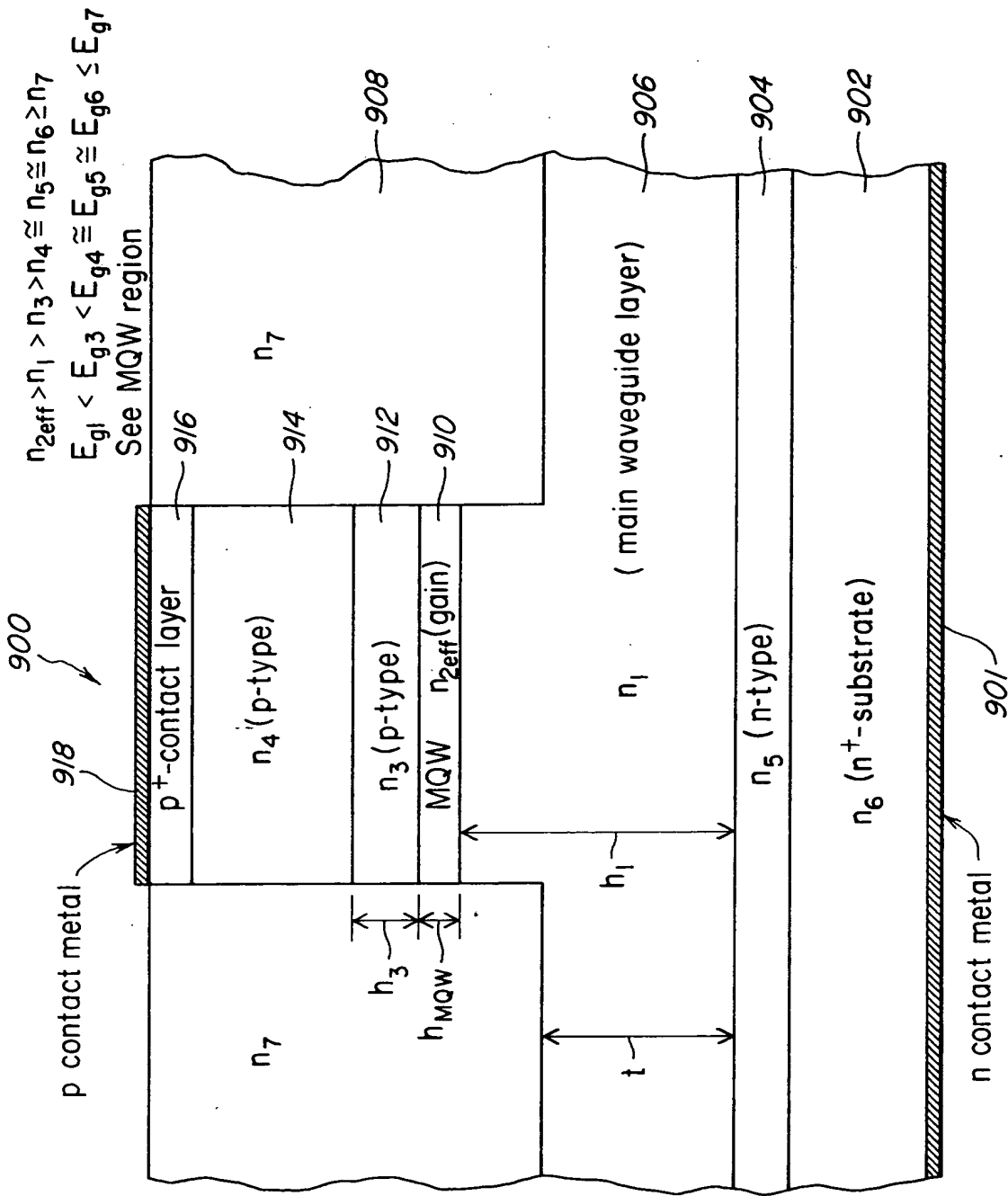

FIG. 9

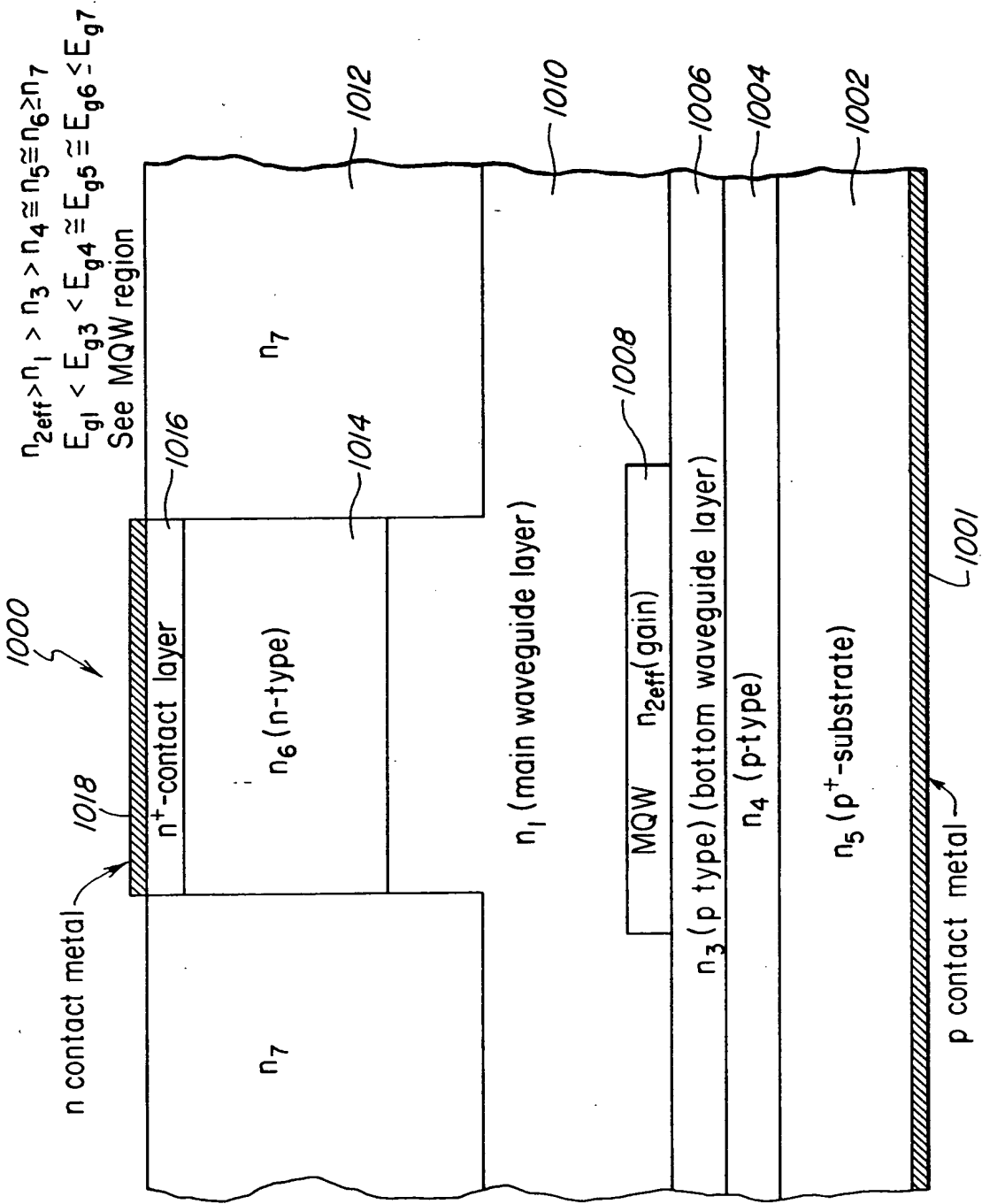

FIG. 10

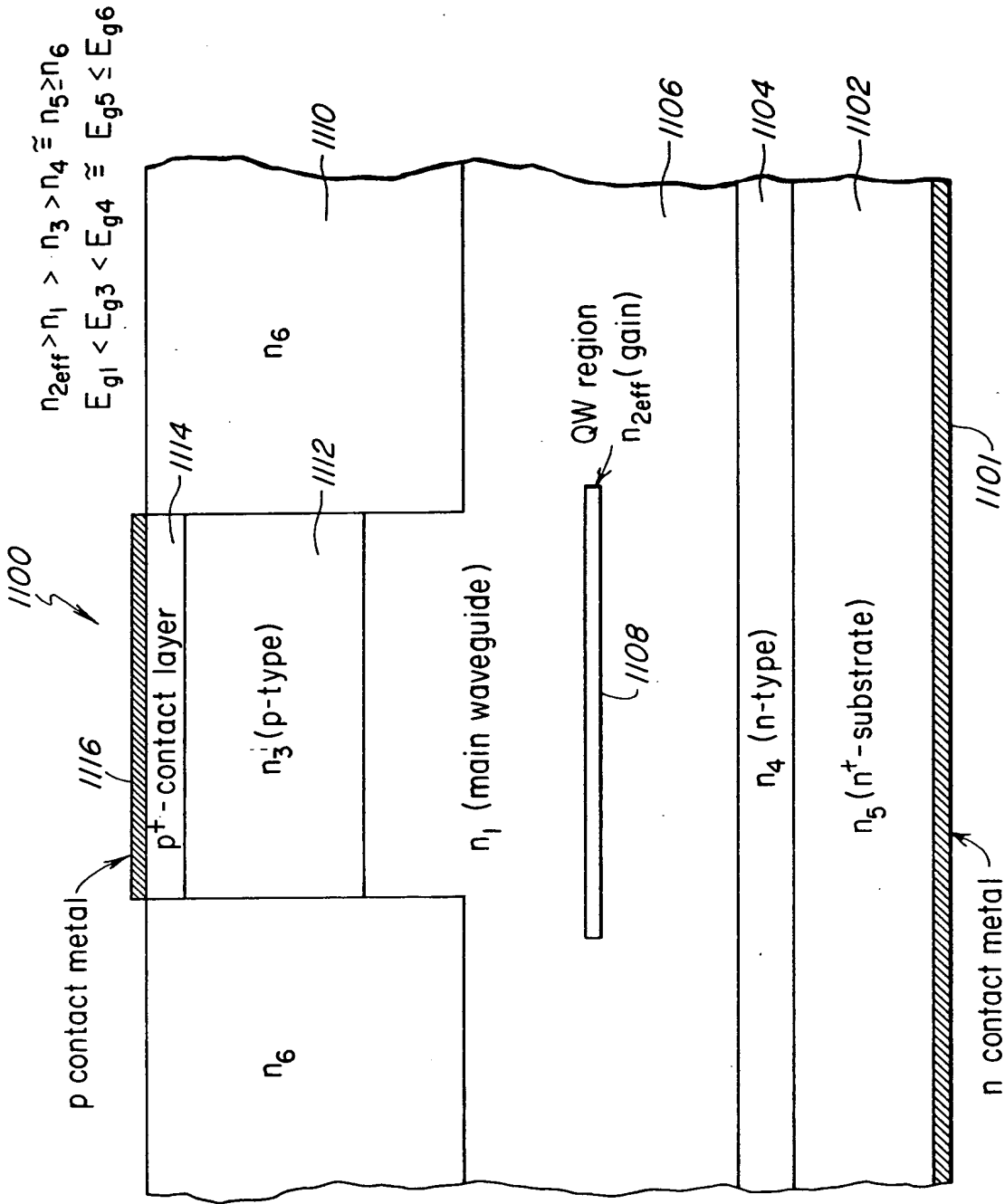
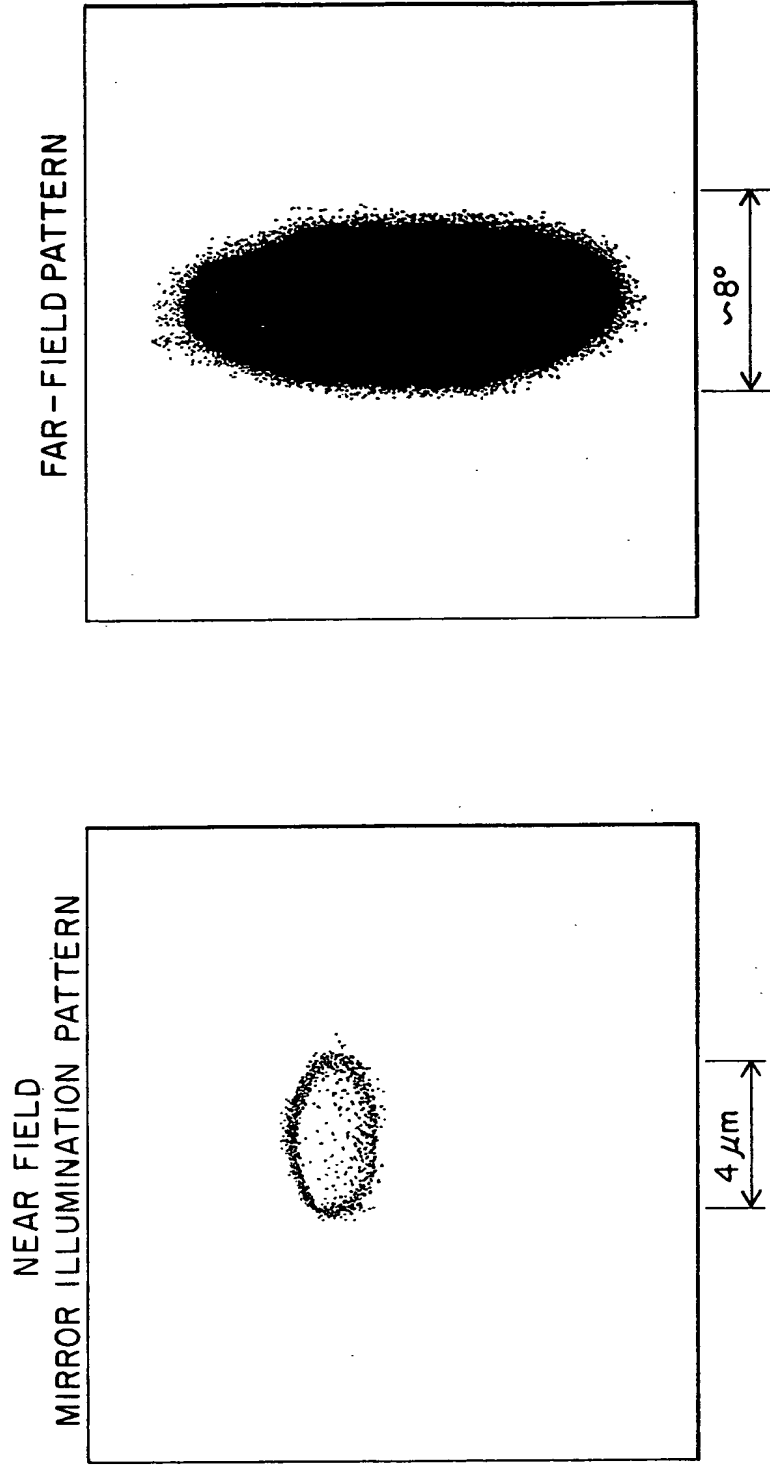
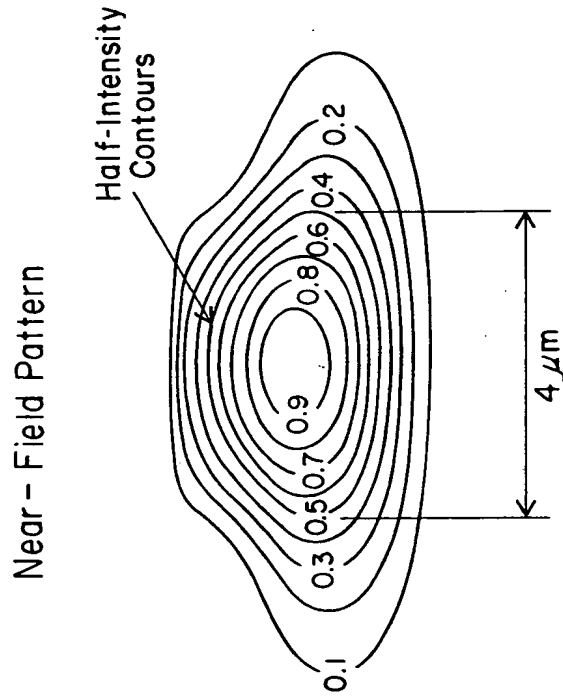
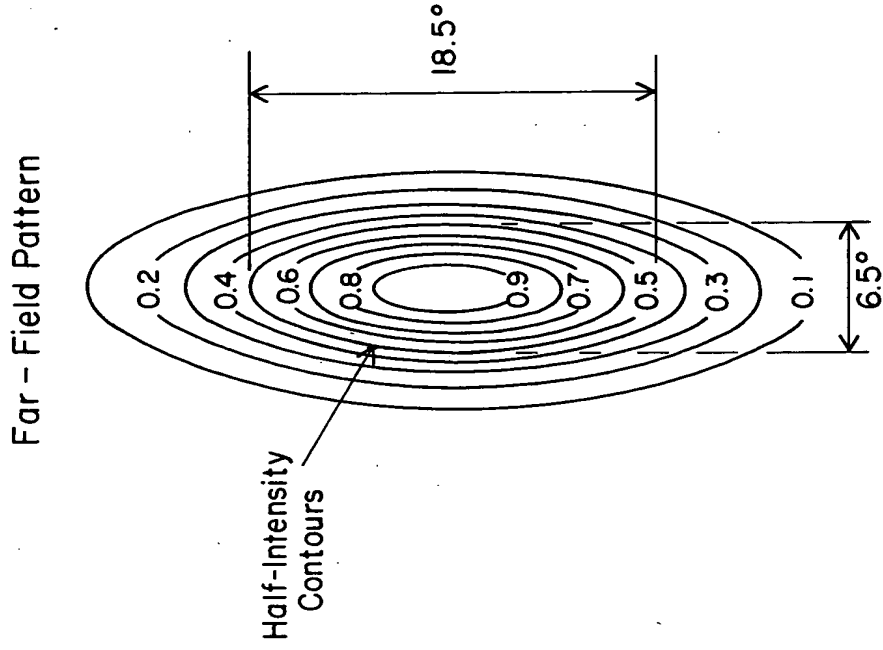

FIG. 11



*FIG. 12B*

*FIG. 12A*



**FIG. 13A**

**FIG. 13B**

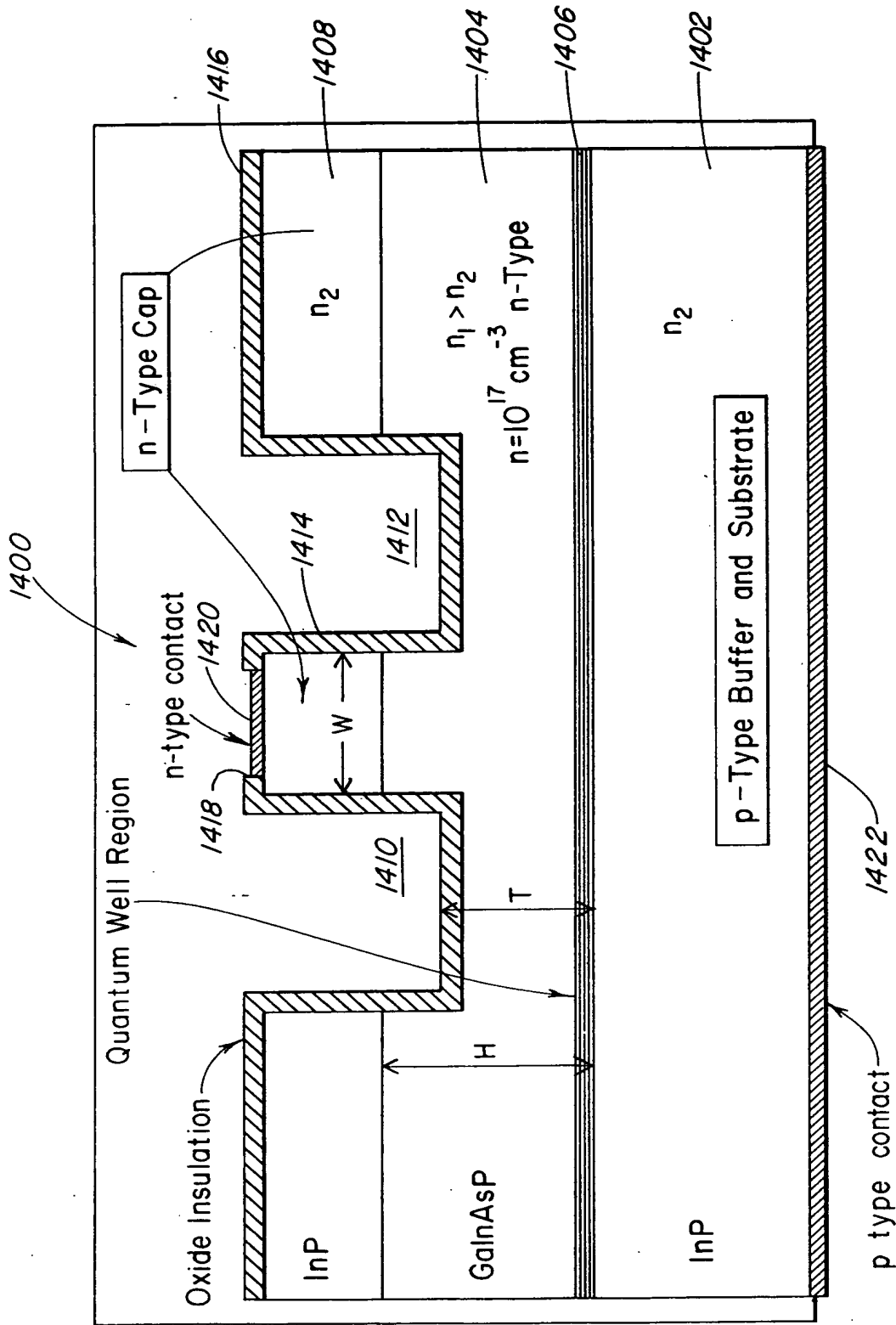

FIG. 14

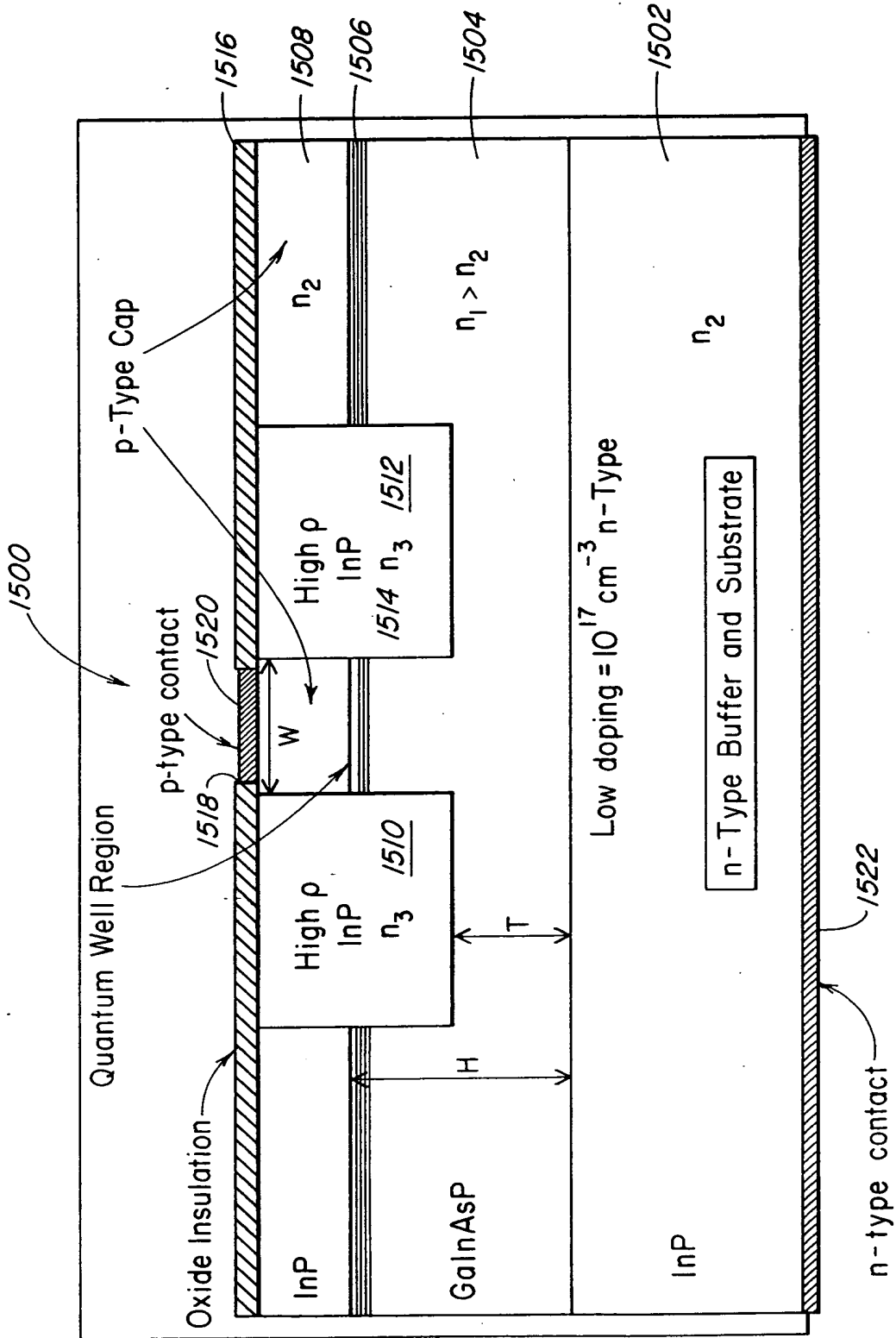

FIG. 15

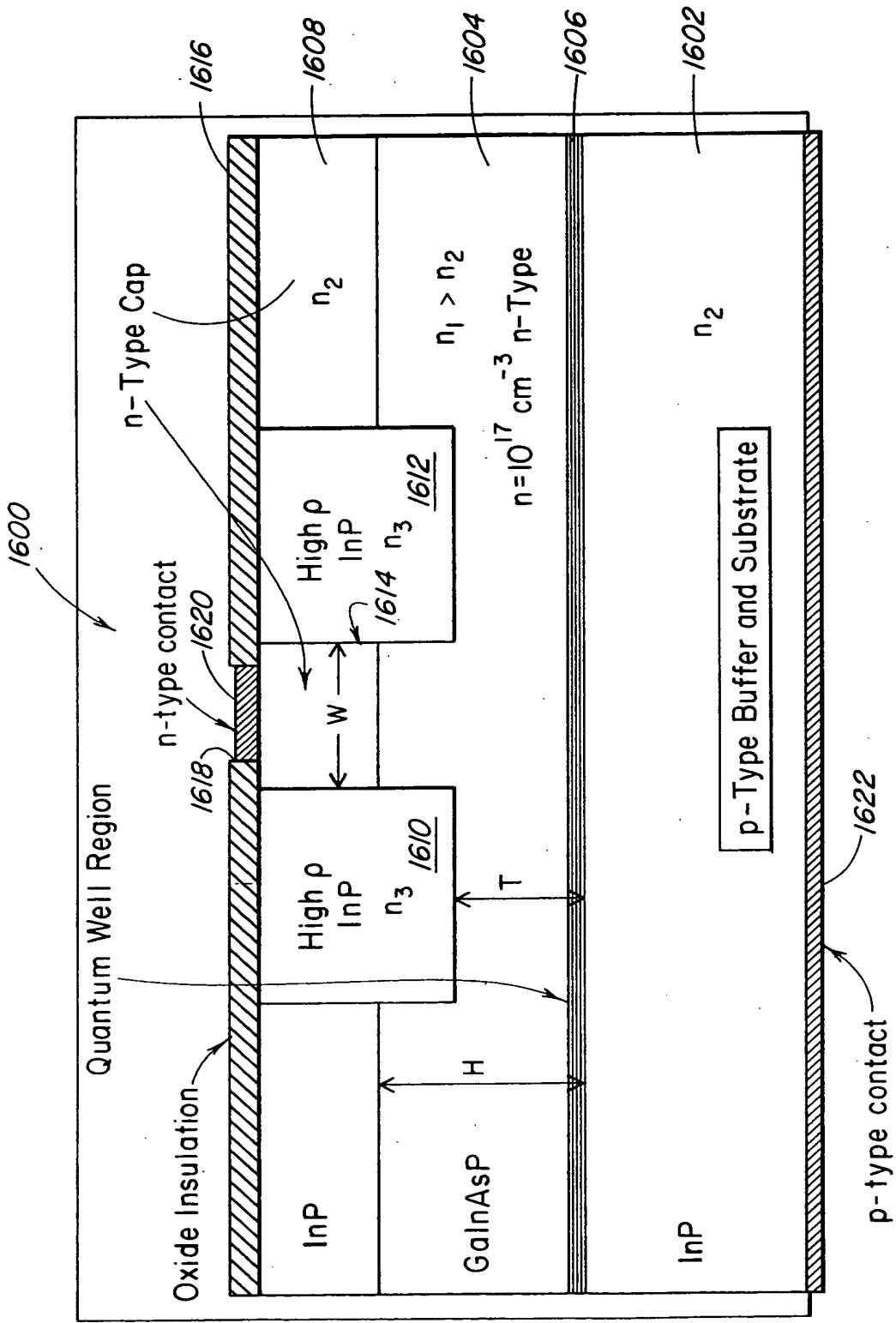

FIG. 16



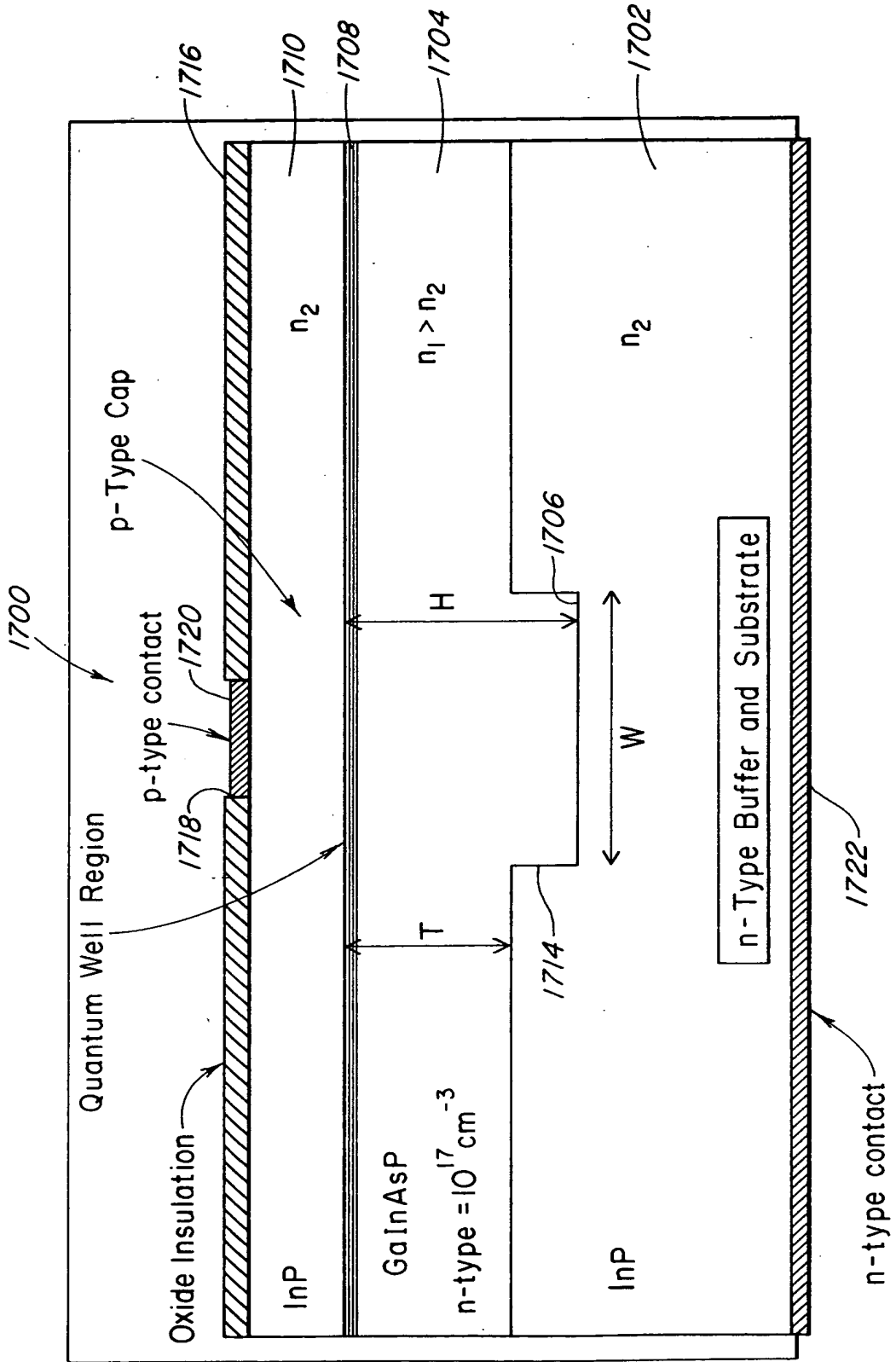

FIG. 17

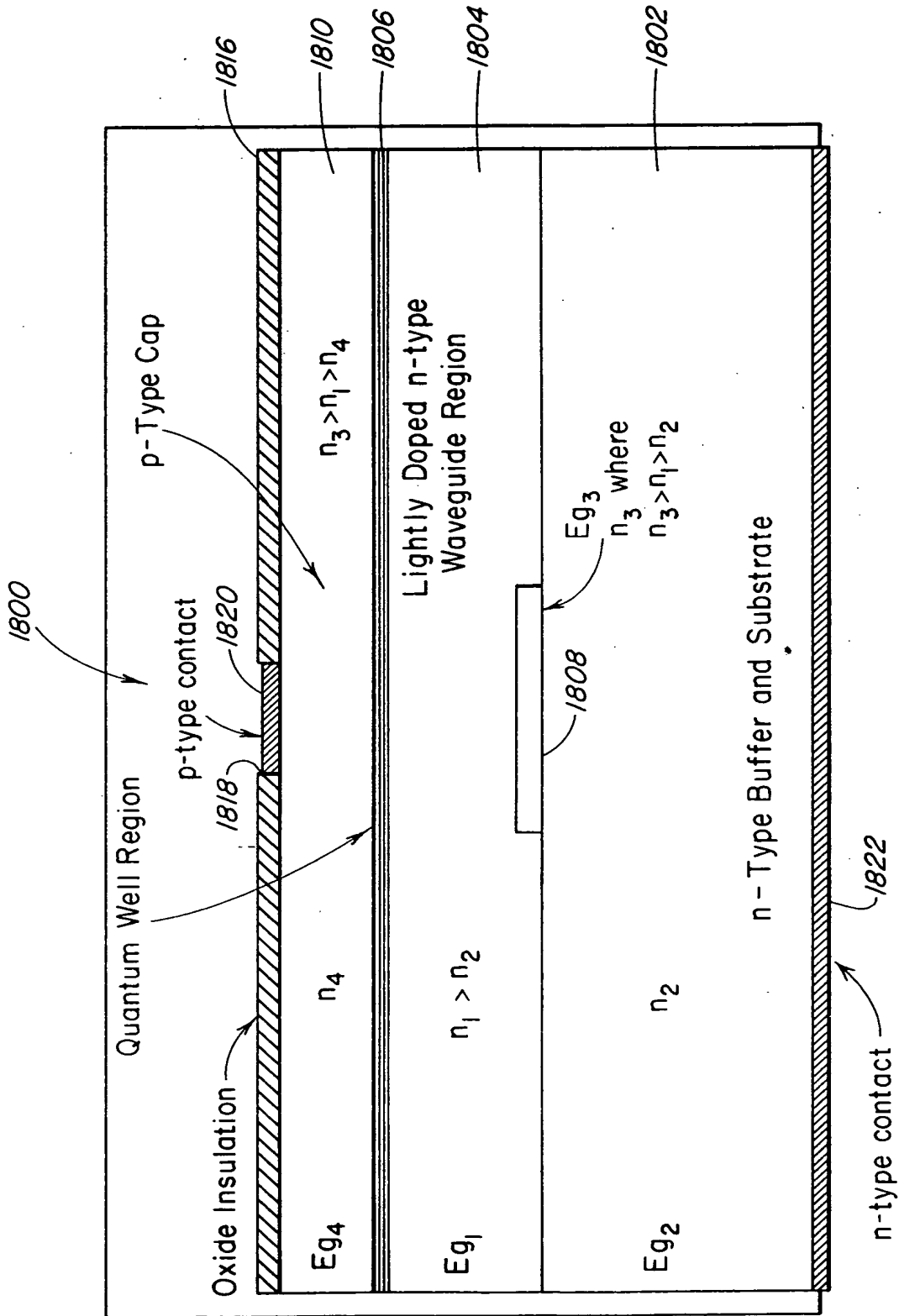

FIG. 18

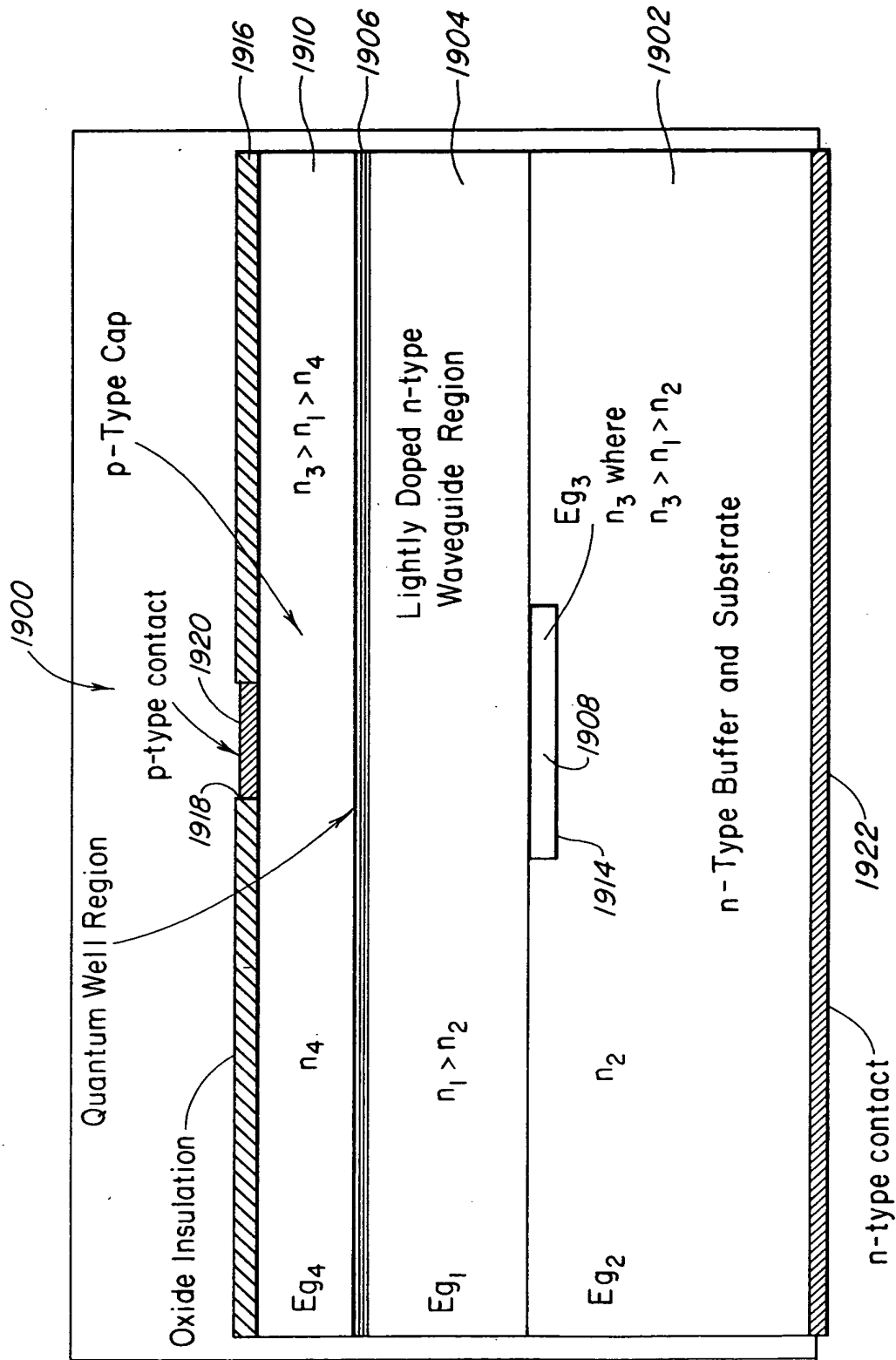

FIG. 19

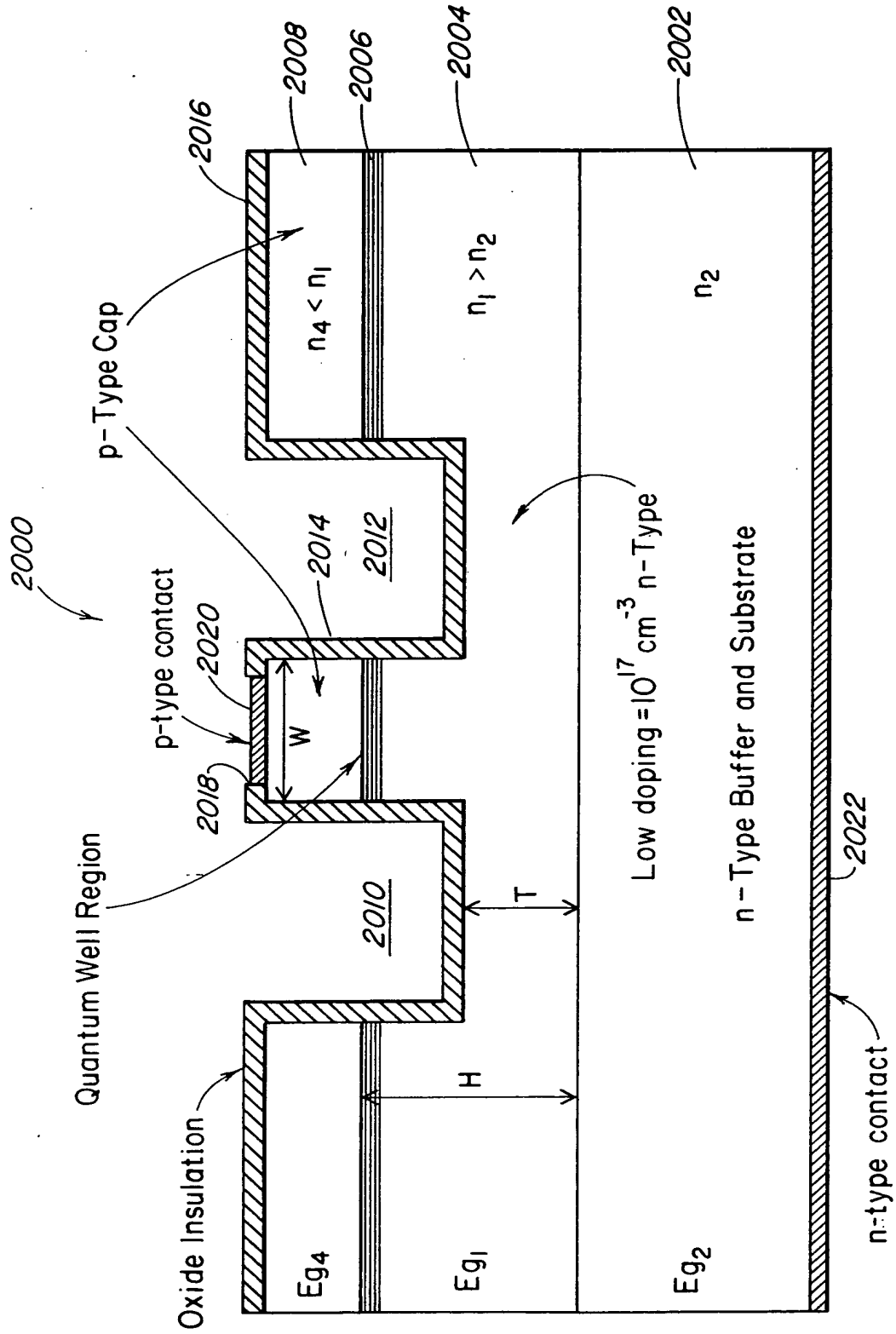
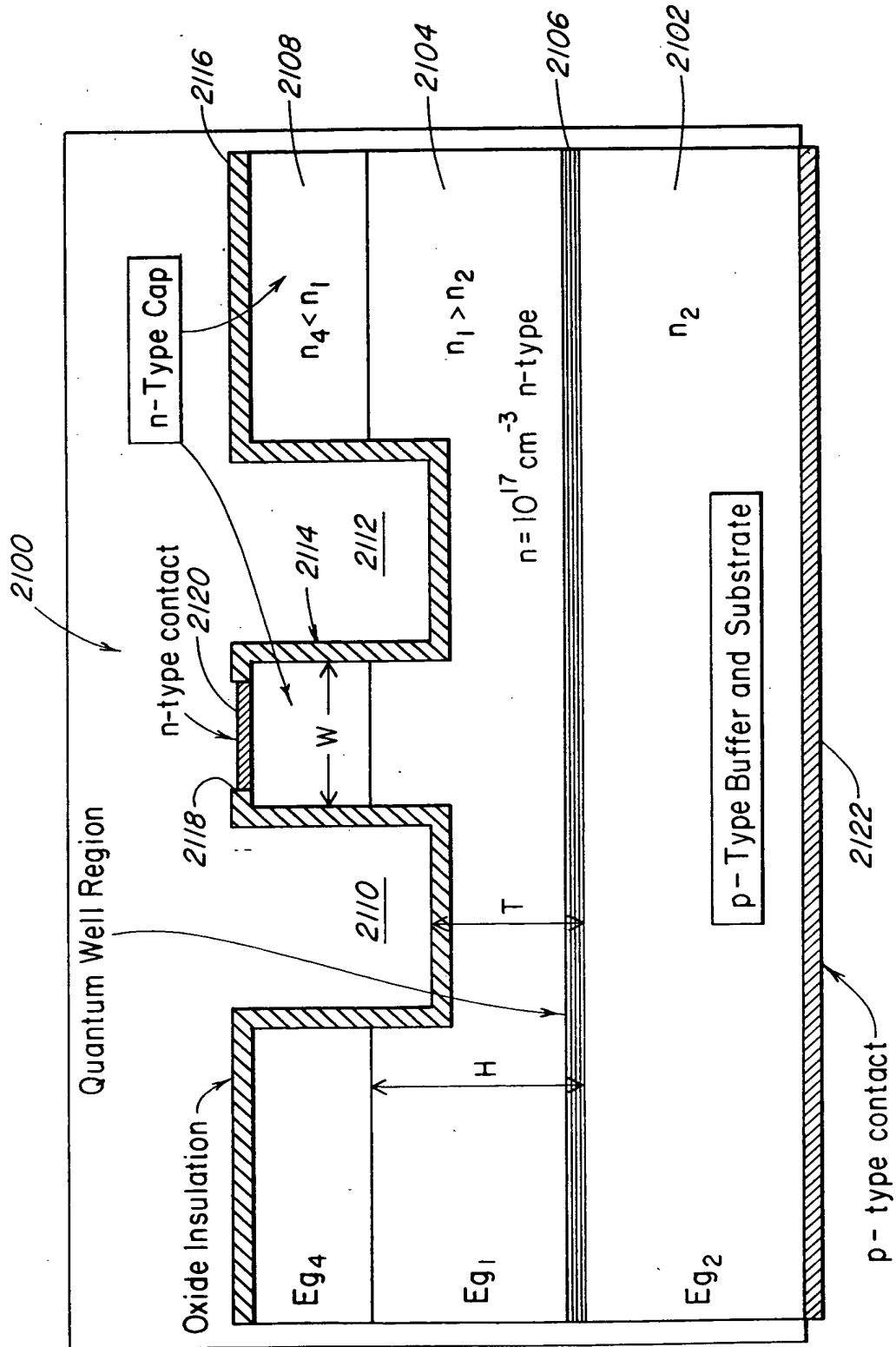
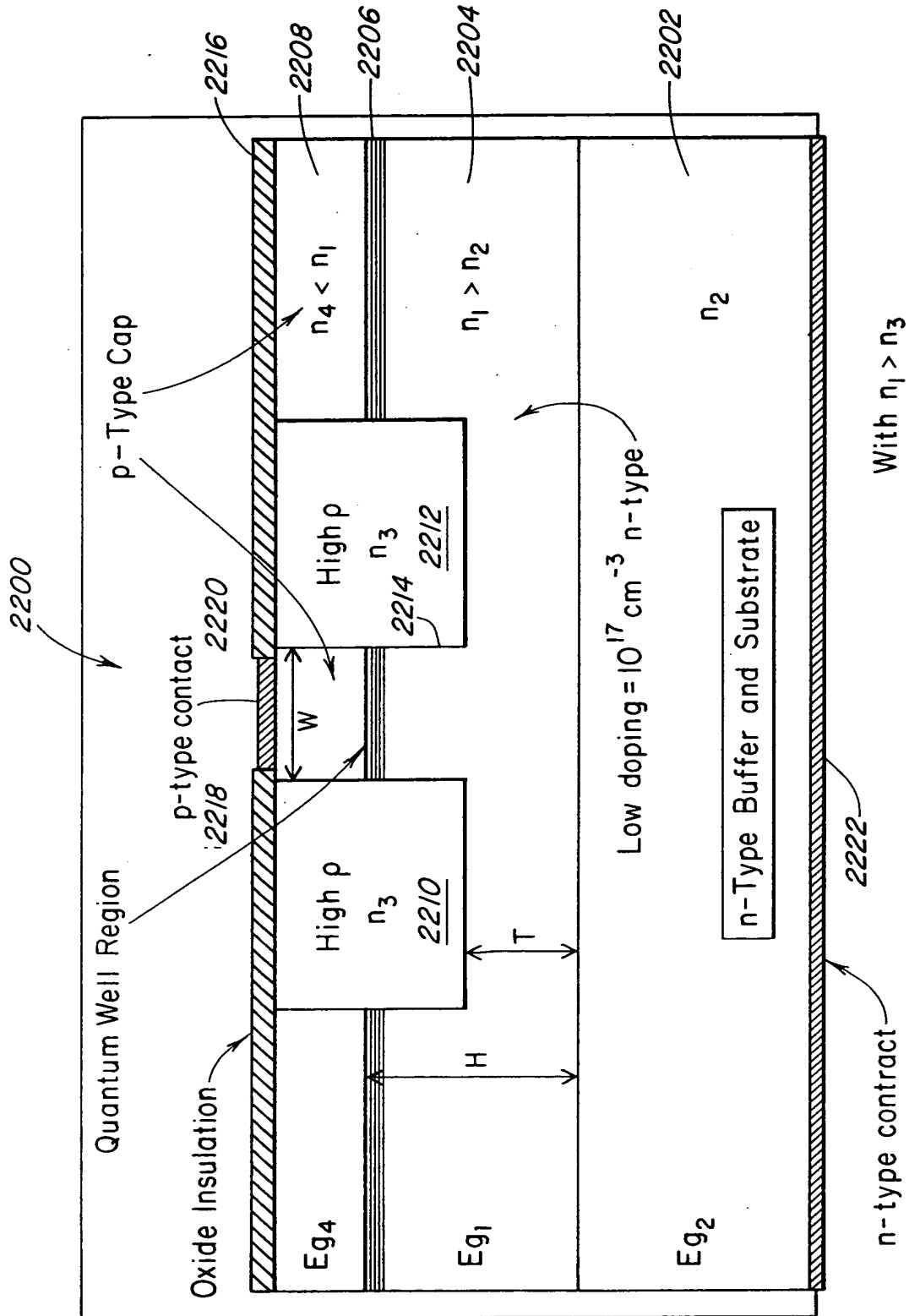

FIG. 20



**FIG. 21**



**FIG. 22**

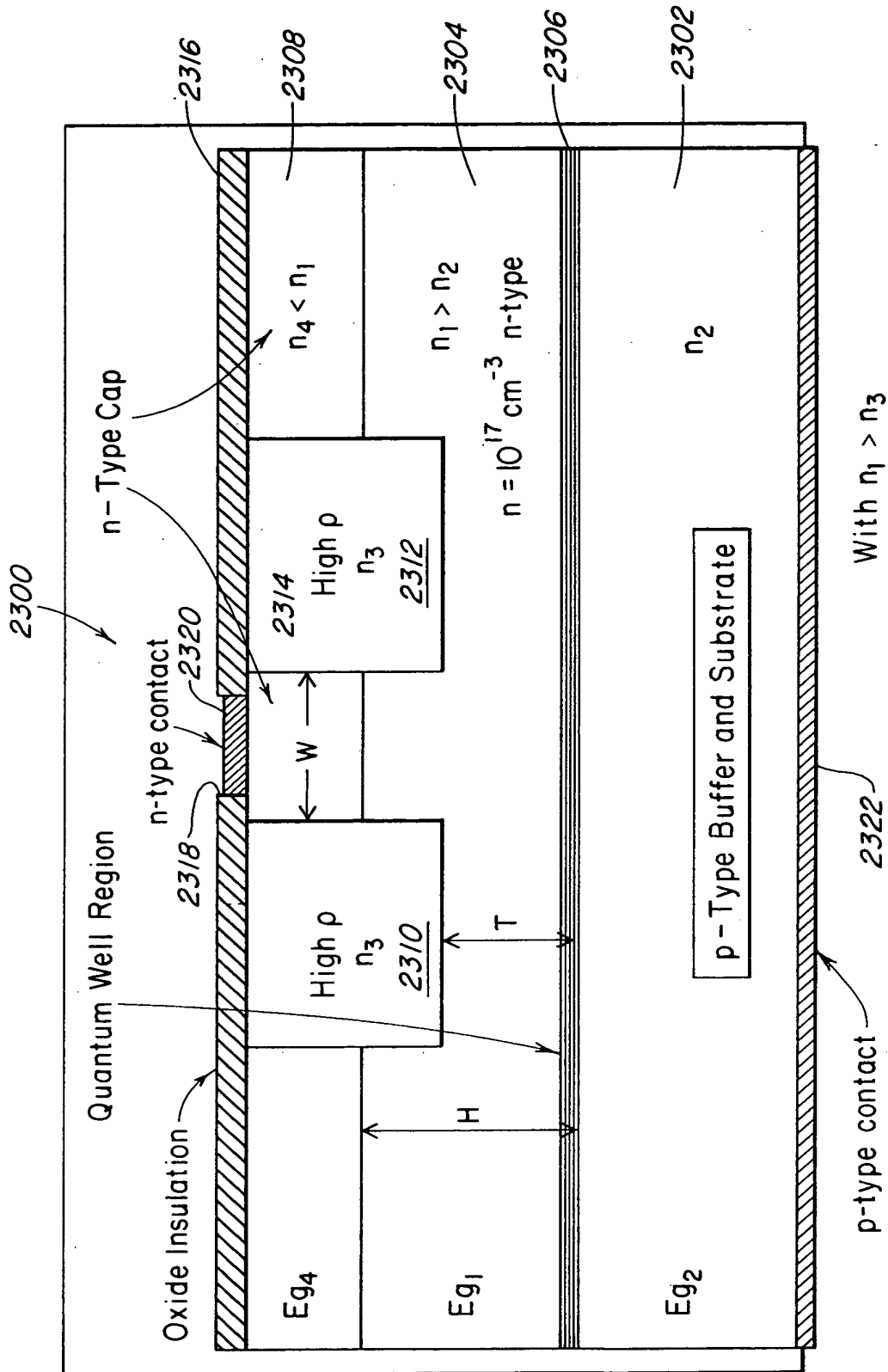

FIG. 23

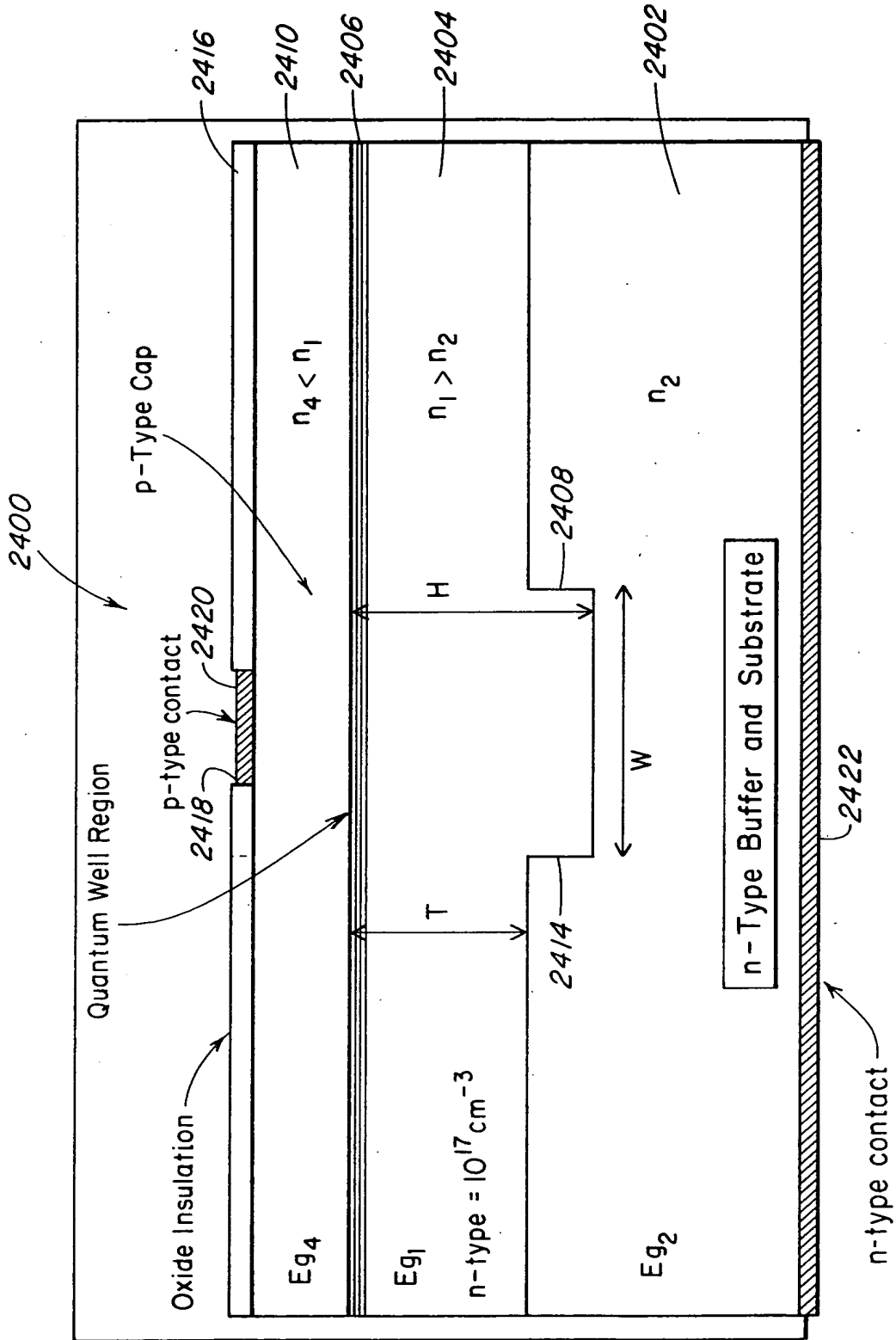

FIG. 24



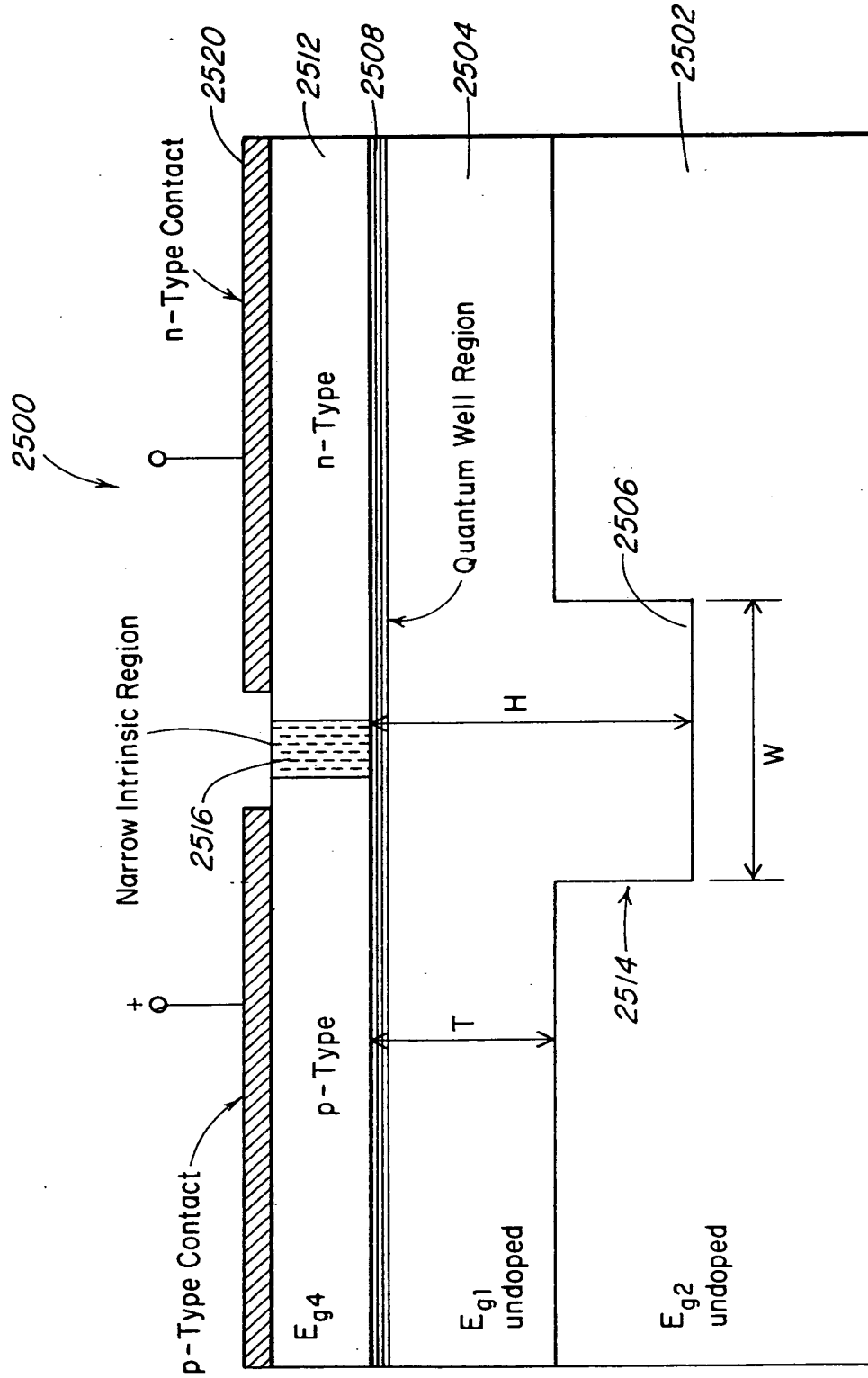

FIG. 25